

Data Sheet



Article number: 03493025

Description: Fluro Heavy Duty Rod end EAL 25 EW-2RS
M24x2 Male thread

Note: 25

Measures

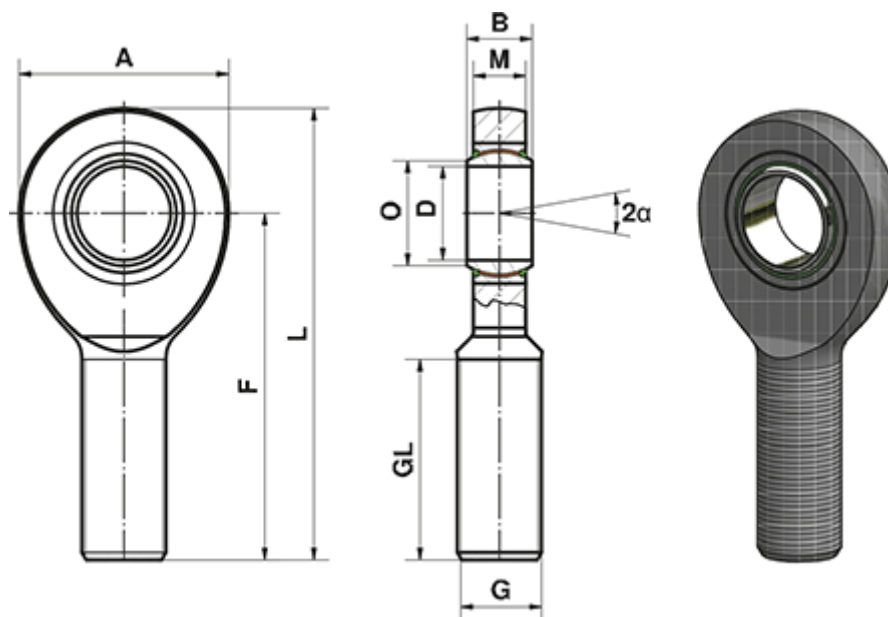

A	= 64	L	= 126
a (degrees)	= 7	M	= 16
B	= 20	O	= 29.3
D	= 25	Static load C0 (kN)	= 92
Dynamic load C (kN)	= 127	Weight (g)	= 560
F	= 94		
G	= M24x2		
GL	= 53		